

MULTI-CODE RECEIVER New Version 2023

- RX Multi - *Power Input:* AC12V-30V DC12V-36V

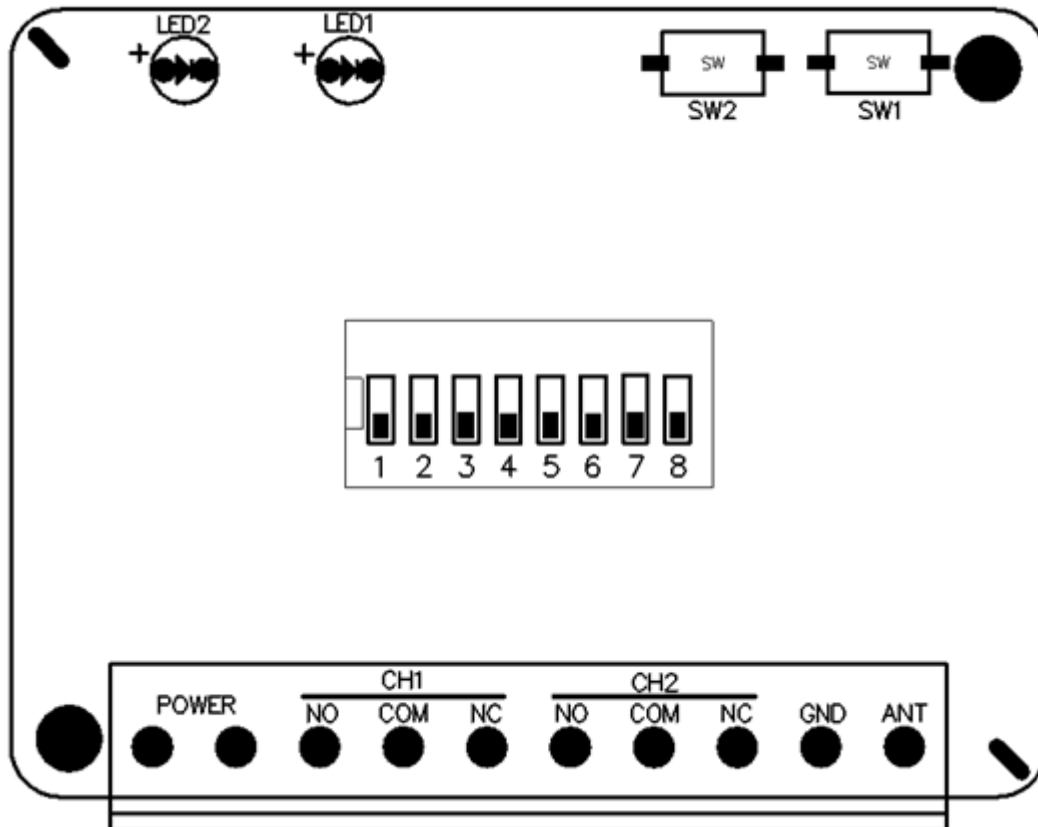

1. Technical Parameters

- Power Input: AC12V-30V DC12V-36V
Users should not exceed these power inputs
- Channel: 2CHS.
- Frequency: 300MHZ-868.8MHZ.
- Memory Capacity: 200 remotes.

2. Brand Select

With an 8-bit dip switch, the user can make different combinations for different remote brands. The brands selection is shown on the table.

3. Learn button and LED

In the Multi receiver there are 2 independent channels. Each channel has an independent learn button S1, S2. The LED L1 corresponds to S1 and the LED L2 corresponds to S2.

4.Operation

How to enter remote and erase all remotes.

Coding the remote:

1. Select the dip switch for the brand and model.
2. Press the learn button S1 or S2, the LED will turn on. Press the button on the remote, the LED flashes 4 times. The selected button has been learnt successfully.
3. Repeat step 2 for any other button.



Please note S1 is Channel 1 and S2 is Channel 2.



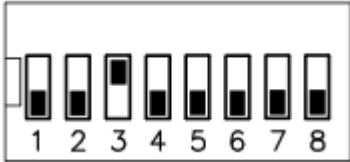
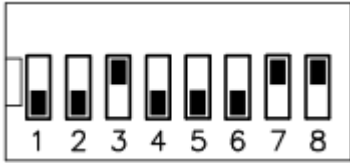
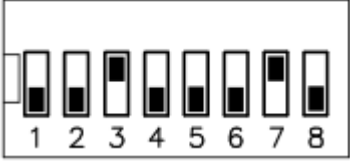

Erase all data in memory card:

Pressing and holding either S1 or S2 learn button, the LED will start to flash. Keep holding this button until the LED turns off. All data in the memory card will be erased permanently.

WARNING: Be careful when erasing all data in the memory card. The data will be erased permanently and cannot be recovered.

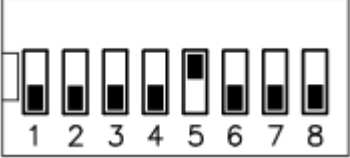
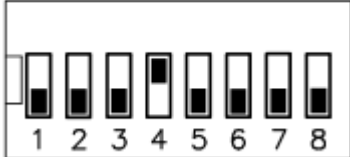
5.Table

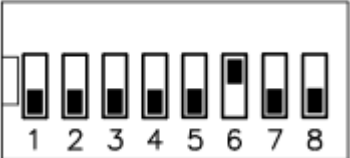
Item	Selection dip switch	Brands	Frequency
1		<ul style="list-style-type: none"> • ATA PTX5 V1 V2 • B&DTriTransV1V2 	ASK 433.92MHZ
2		<ul style="list-style-type: none"> • Merlin+2.0 	ASK 433.92MHZ
3		<ul style="list-style-type: none"> • Merlin+ 	ASK 433.92MHZ
4		<ul style="list-style-type: none"> • Merlin 842 	FSK 433.92MHZ
5		<ul style="list-style-type: none"> • BOSS Steeline BHT4 303 	ASK 303 MHZ

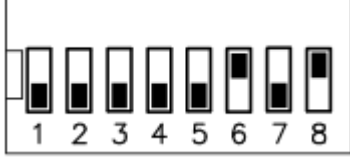
6		<ul style="list-style-type: none"> • ATA PTX4 • BFT • SEIP TM 60 • Doorworks • M House • HERCULIFT • Superlift /Avanti, • Nova/Centsys • KEY • FORZA • Steeline ZT07 • Magic Button • Dace • BENINCA • DEA • 4D Doors 	ASK 433.92MHZ
7		<ul style="list-style-type: none"> • GLIDEROL 305C 	ASK 315MHZ
8		<ul style="list-style-type: none"> • PTX4 B&D 	ASK 433.92MHZ
9		<ul style="list-style-type: none"> • CAME • Ditec GOL4C\BIXP2 • MARANTEC • BOSS BHT3 • KINGATES 	ASK 433.92MHZ
10		<ul style="list-style-type: none"> • NICE FLORS • NICE Era-Inti 	ASK 433.92 MHZ
11		<ul style="list-style-type: none"> • FAAC SLH Rolling Code 	FSK 433.92 MHZ